

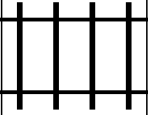
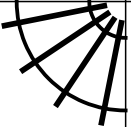
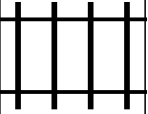

PUZZLE MADNESS

Daily Train Tracks Puzzle for Saturday 17th February 2007

1 6 4 6 3 1

						3
						3
						2
						4
						4
						3
						2