

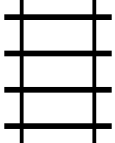



PUZZLE MADNESS

Daily Train Tracks Puzzle for Saturday 7th February 2026

2 6 4 5 2 1

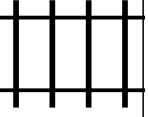
						1
						3
						3
						3
						2
						4
						4